

SECTION A

GENERAL INFORMATION

ALL SERIES

CONTENTS

Division	Subject	Paragraph
I	TROUBLE DIAGNOSIS: (Not Applicable)	-
II	DESCRIPTION AND OPERATION: (Not Applicable)	-
III	ADJUSTMENTS AND MINOR SERVICE: Keys and Locks.	00-1
IV	REMOVAL AND INSTALLATION: (Not Applicable)	-
V	OVERHAUL AND MAJOR SERVICE: (Not Applicable)	-
VI	SPECIFICATIONS: 1971 Model Chart. Standard Rear Axle Ratios. Paint Color Code Chart. Convertible Top Color Code Chart. Vinyl Top Color Code Chart. Vehicle and Major Component Identification Numbers. General Specifications.	00-2 00-3 00-4 00-5 00-6 00-7 00-8
		00A-7

DIVISION III

ADJUSTMENTS AND MINOR SERVICE

00-1 KEYS AND LOCKS

All 1971 model Buick cars are equipped with a new five biting level lock cylinder and key. Five biting levels are used to form one of 2,000 possible combinations.

Two non-interchangeable keyways are used. One keyway, known as the "A" type, is used in ignition and door lock cylinders. The second keyway, known as the "B" type is used in the glove compartment, console compartment and rear compartment lock cylinders.

To fit these lock cylinders, two keys are required. The ignition and door lock key for these five level lock cylinders may be identified by a small capital "A" stamped on one side of the key. The "A" type key has a rectangular type head. A second key is used for the glove, console, and

rear compartment locks. This key has an oval head and may be identified by a small capital "B" stamped on one side. These marks serve to distinguish the keys for five level locks from those used in previous years.

Because of the way in which the key blade is grooved, each key will fit *only* the type of lock it is to be used in.

For Service replacement keys, see subparagraph a.

Key code numbers are stamped on the "knock-out" plug in the key head. After the code has been recorded by the owner to facilitate replacements or duplications of a key, the plugs should be knocked out of the key heads. If key code numbers are not available from records or from the "knock-out" plug, the code can be determined by laying the key on the diagram in Figure 00-1, or from the ignition lock cylinder housing and glove compartment lock assemblies themselves. The station wagon ignition lock cylinder will be marked with the key code number for the tailgate lock cylinder, the door lock cylinders and ignition lock cylinder.

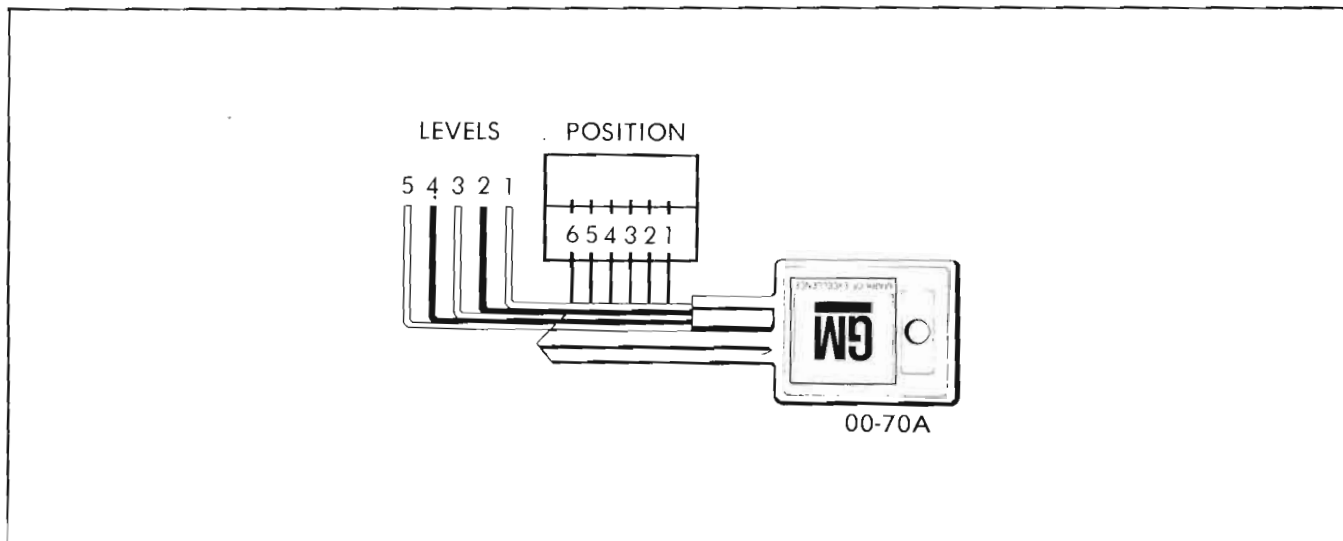

Figure 00-1 - Key Code Diagram

For "A" type lock cylinders assemblies, the key code number is stamped on the ignition lock cylinder housing; for "B" type lock cylinder assemblies, the number is stamped on the glove compartment (marked on the tumbler carrying plug) lock cylinder. From these numbers the lock combination can be determined by use of a code list for cutting new keys for coding a replacement service lock cylinder assembly. Door lock, rear compartment, and tailgate lock cylinders coded by the car division do not have key code numbers stamped on them; therefore, codes may be determined either from a ignition or glove compartment lock cylinder of the same car which will have the same lock tumblers, or from the key code diagram. See Figure 00-1.

a. Cutting Keys

After the special code has been determined, either from the code list or the Key Code Diagram, cut a blank key to the proper level for each of the six tumbler positions, and check the key in the lock cylinder. The new key should agree with the combination opposite the code number in the code list.

b. Removal and Installation of the Ignition Lock

Remove and install the ignition lock assembly from the steering column following the procedures outlined in Group 90.

c. Selecting Lock Cylinder Tumblers

NOTE: *The 1971 factory-installed ignition lock is not serviceable. Should failure require service, a new ignition lock package is available from the Parts Department less tumblers. Tumblers are also available and must be installed into the ignition lock cylinder according to the following special code.*

When it is necessary to code a new lock cylinder to agree with a key code number, install the proper tumblers into

their respective slots, as indicated by Key Code Diagram or Briggs and Stratton Code List.

Tumblers for all locks except the glove and console compartments are shaped exactly alike, with the exception of the position of a notch on one side. Tumblers for glove and console lock cylinders are different and will not interchange with any other lock tumblers. As the key is inserted in the lock cylinder, the tumblers are raised to the correct height so that the notches on each tumbler are on the same level. When the notches on all six tumblers line up, the locking bar is pushed into the notches by two small springs, allowing the cylinder to turn in its bore. Five types of tumblers are used to make all the various lock tumbler combinations and each is coded according to a number, 1 through 5, stamped on its side.

Only one type of tumbler is used to make the various lock tumbler combinations for glove and console compartment locks. Tumblers for these two lock cylinders are of a different design than the tumblers used in all other lock cylinders.

As the key is inserted in the lock cylinder, each tumbler is depressed so that no part of any tumbler is exposed above the level of the lock cylinder allowing the cylinder to turn in its bores. Refer to subparagraph f, to assemble glove and console compartment lock cylinders.

To determine which tumblers should be installed in what position for a given key, when a code list is not available, proceed as follows:

1. Lay the key on the Key Code Diagram, Figure 00-1, with the key outlined by the diagram as accurately as possible.
2. Starting at the base of the key blade, determine the lowest level that is visible in position No. 1.

3. Determine the lowest visible level for the remaining five positions. As each tumbler level is determined, write that number in the blank space provided above the position numbers.

4. Cuts that fall in the first white section, mark Level No. 1 on top of appropriate position number.

5. Cuts that fall in the first black section, mark No. 2 on top of appropriate position number.

6. Cuts that fall in the second white section, mark No. 3 on top of appropriate position number.

7. Cuts that fall in the second black section, mark No. 4 on top of appropriate position number.

8. Cuts that fall in the third white section, mark No. 5 on top of appropriate position number.

d. Installing Lock Cylinder Tumblers (Except Glove and Console Compartments)

After the tumbler arrangement has been determined as shown in subparagraph c, ignition and door lock cylinders should be assembled as follows:

1. Hold cylinder with head of cylinder away and starting at the head of the cylinder, insert the tumblers in their proper slots in the order called for by the code, ribbed side toward you and long point down. See Figure 00-2.

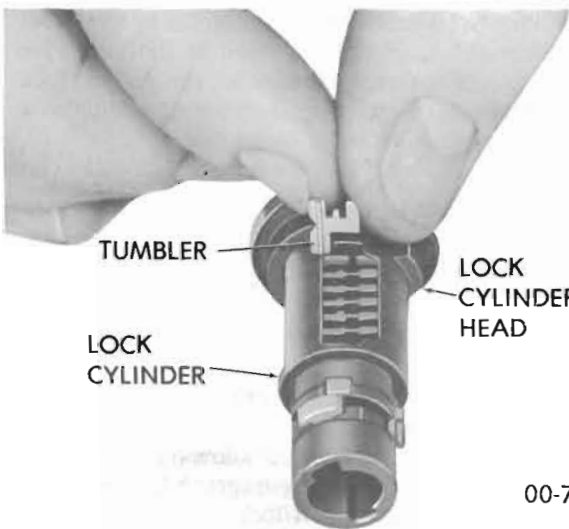

Figure 00-2 - Installing Tumblers

2. Insert one tumbler spring in the space provided above each tumbler.

CAUTION: *If the springs become tangled, do not pull them apart - unscrew them.*

3. Reverse the lock cylinder so that the head of the cylinder is now toward you. Insert the spring retainer so that

the two end prongs slide into the slots at either end of the cylinder. Press the retainer down. See Figure 00-3.

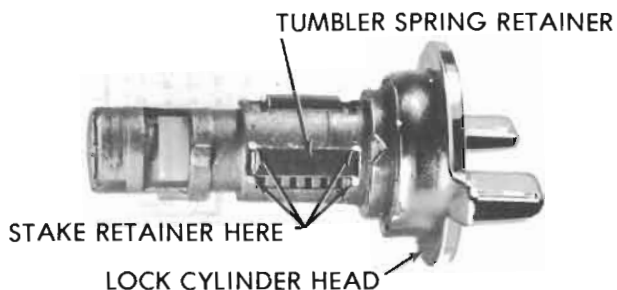

Figure 00-3 - Installing Spring Retainer

4. To check, insert proper key and if tumblers are installed properly the side bar will be allowed to drop down. If bar does not drop down, remove the key, spring retainer, springs and tumblers and reassemble correctly.

NOTE: *If the tumblers have not been assembled correctly, they can be removed from the cylinder by holding it with the tumbler slots down, pulling the locking bar out with the fingers and jarring the cylinder to shake the tumblers out. This procedure is necessary because once the tumblers have been pressed down into the cylinder they are held in their slots by the side bar.*

5. If after checking, it is found that the lock is assembled properly, remove key and secure cylinder in a vise with spring retainer exposed. Use leather or wood at each vise jaw to prevent damage to the cylinder.

6. Stake the retainer securely in place by staking the cylinder metal over both edges at each retainer end using a suitable staking tool at right angles to the top of the retainer.

e. Assembling Service Ignition Locks

1. Place the key part way into the lock cylinder assembly. Place the wave washer and anti-theft ring onto the lower end of the lock cylinder.

NOTE: *If the key is installed all the way into the lock cylinder, the plastic keeper in the lock cylinder protrudes and prevents installation of the sleeve assembly.*

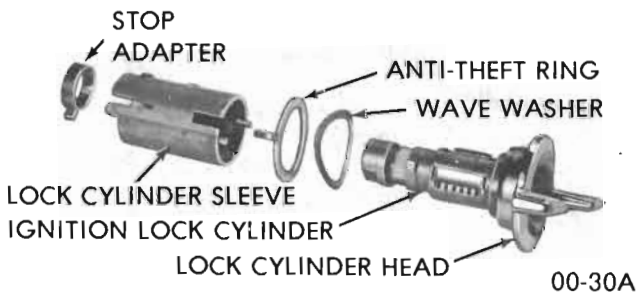

Figure 00-4 Ignition Lock Assembly - Exploded View

2. Make sure that the plastic keeper in the sleeve assembly protrudes from the sleeve.

3. Align the lock bolt on the lock cylinder and the tab on the anti-theft washer with the slot in the sleeve assembly. Push the sleeve all the way onto the lock cylinder assembly, push the ignition key the rest of the way in and rotate the lock cylinder clockwise. See Figure 00-5.

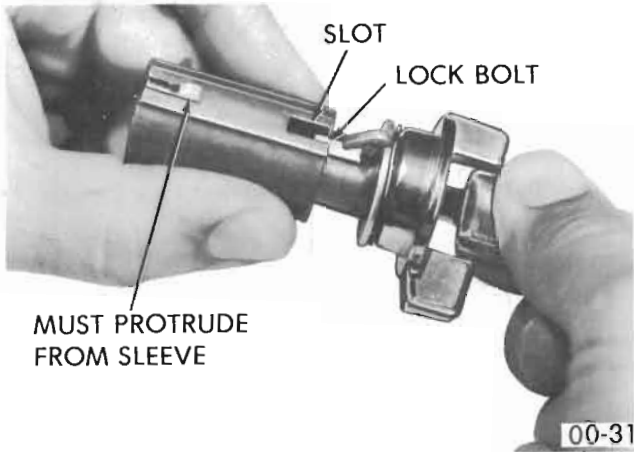

Figure 00-5 Ignition Lock - Assembly

4. Place assembled ignition lock assembly into vise with wood blocks to protect finish. Place stop adapter on lock cylinder with stop positioned down. See Figure 00-6.

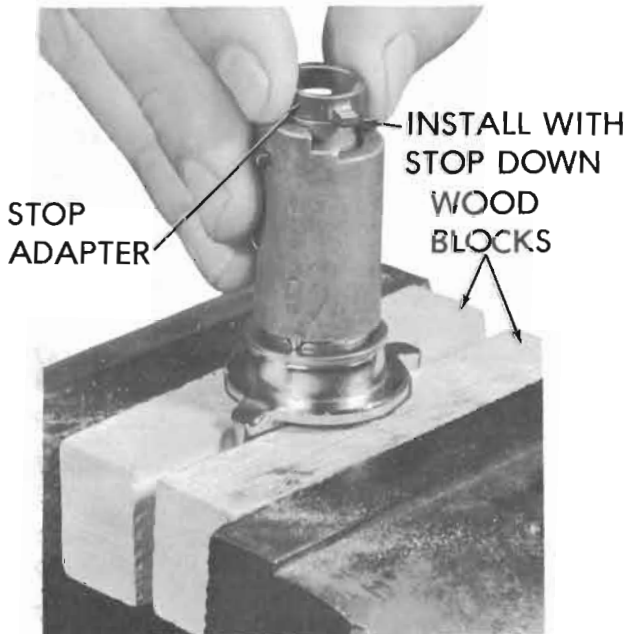

Figure 00-6 Installing Stop Adapter on Lock Cylinder

5. Using a hammer and a small pin punch, stake lock cylinder at four (4) places to retain stop adapter. Do not use force when striking cylinder, as metal is soft and only a light tap with a hammer is necessary. See Figure 00-7.

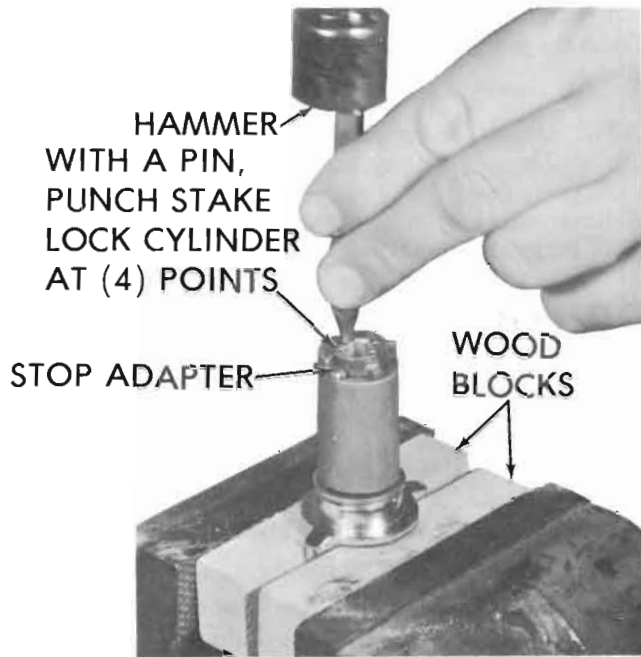

Figure 00-7 Staking Lock Cylinder to Retain Lock Adapter

f. Assembling Glove and Console Compartment Lock Cylinders

NOTE: These two lock assemblies are equipped with four or five tumblers rather than six required in other locks. Tumblers for positions 3-4-5-6 or 2-3-4-5-6 only. Do not install tumblers which correspond to positions 1 and 2 on the key. The non-brass "tumbler" that is closest to the head of the lock cylinder is a locking device and must not be removed unless damaged. See Figure 00-8.

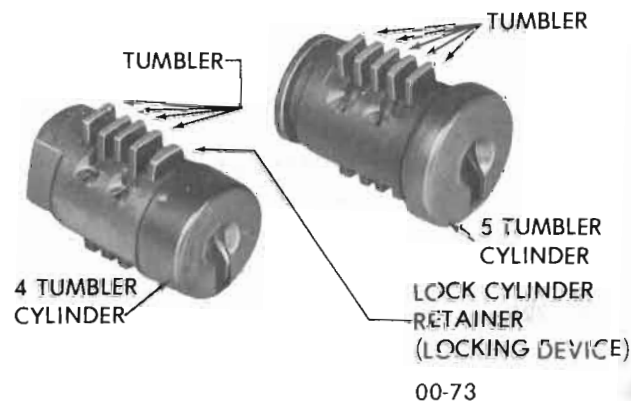

Figure 00-8 - Glove Compartment Lock Cylinder

1. Insert properly coded key in position.
2. Place cylinder in a vise using leather or wood at each vise jaw to prevent damage to the cylinder.
3. File tumblers down so that no part of any tumbler extends above the lock cylinder. A standard 5/8" double cut bastard file is recommended for this operation. To finish the job, use a flat 5-1/2" No. 2 cut needle equaling file.

NOTE: Do not file any part of black "tumbler" in position No. 2. This is a locking bar and should not be altered.

4. Reverse lock cylinder position in vise and repeat Step 5 for bottom of tumblers. See Figure 00-7.

LOCK CYLINDER RETAINER

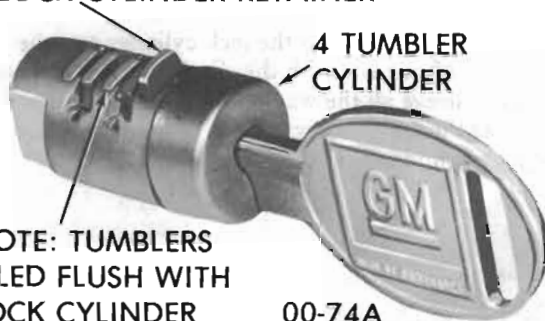

00-74A

Figure 00-9 - Coded Glove Compartment Lock Cylinder

DIVISION VI

SPECIFICATIONS

00-2 1971 MODEL CHART

Series	Body Style	Designation
Skylark	2-Door Coupe Thin Pillar	43327
	2-Door Coupe Hardtop	43337
	4-Door Sedan Thin Pillar	43369
Skylark Custom	2-Door Coupe Hardtop	44437
	2-Door Convertible	44467
	4-Door Hardtop	44439
	4-Door Sedan Thin Pillar	44469
GS	2-Door Coupe Hardtop	43437
	2-Door Convertible	43467
Sportwagon	4-Door 2-Seat Wagon	43436
LeSabre	2-Door Coupe Hardtop	45257
	4-Door Hardtop	45239
	4-Door Sedan Thin Pillar	45269
LeSabre Custom	2-Door Coupe Hardtop	45457
	2-Door Convertible	45467
	4-Door Hardtop	45439
	4-Door Sedan Thin Pillar	45469
Estate Wagon	4-Door 2-Seat Wagon	46035
	4-Door 3-Seat Wagon	46045
Centurion	2-Door Coupe Hardtop	46647
	2-Door Convertible	46667
	4-Door Hardtop	46639
Electra 225	2-Door Coupe Hardtop	48237
	4-Door Hardtop	48239
Electra 225 Custom	2-Door Coupe Hardtop	48437
	4-Door Hardtop	48439
Riviera	2-Door Coupe Hardtop	49487

00-3 STANDARD REAR AXLE RATIOS

Models	Engine	Transmission	Standard
43327-37-69	250 L-6	3-Speed Manual/THM-350	3.08
43327-37-69		3-Speed Manual	3.08
44437-39-69-67	350 V-8	THM-350 2 BBL	2.56
		THM-350 4 BBL	2.73
43437-67	350 V-8	3 & 4-Speed Manual/THM-350	3.08
43436	350 V-8	3-Speed Manual/THM-350	3.08
43437-67	455 V-8	4-Speed Manual	3.42
	455 V-8	THM-400	3.08
	455 GSX	4-Speed Manual/THM-400	*3.42
	455 STG I	4-Speed Manual/THM-400	*3.42
45257-39-69		3-Speed Manual	3.42
45457-67-39-69	350 V-8	THM-350	3.08
45257-39-69		3-Speed Manual	3.42
45457-67-39-69	455 V-8	THM-400	2.93
46035-45	455 V-8	3-Speed Manual	3.42
		THM-400	2.93
46647-67-39	455 V-8	THM-400	2.93
48237-39			
48437-39	455 V-8	THM-400	2.73
49487			
49487 GS	455 V-8	THM-400	2.93
			*3.42 PT

*Positive Traction

00A-9

00-4 PAINT COLOR CODE CHART

SALES CODE	SERV. CODE	COLOR NAME
A	19	REGAL BLACK
B	26	STRATOMIST BLUE
C	11	ARCTIC WHITE
D	24	CASCADE BLUE
E	29	NOCTURNE BLUE
F	70	PEARL BEIGE
G	55	CORNET GOLD
H	43	LIME MIST
I	39	TWILIGHT TURQUOISE
J	68	DEEP CHESTNUT
K	42	WILLOMIST GREEN
L	16	TEALMIST GRAY
M	49	VERDEMIST GREEN
N	78	ROSEWOOD
P	13	PLATINUM MIST
Q	53	CORTEZ GOLD
R	75	FIRE RED
S	65	COPPER MIST
T	62	BITTERSWEET MIST
U	67	BURNISHED CINNAMON
V	73	SUNSET MIST
W	61	SANDPIPER BEIGE
X	74	VINTAGE RED
Y	50	BAMBOO CREAM
Z	41	SILVER FERN

00A-10

00-5 CONVERTIBLE TOP COLOR CODE CHART

SALES CODE	SERV. CODE	COLOR NAME
1	A	WHITE
2	B	BLACK
5	E	SANDALWOOD
9	G	DARK GREEN

00A-12

00-6 VINYL TOP COLOR CODE CHART

SALES CODE	SERV. CODE	COLOR NAME
1	A	WHITE
2	B	BLACK
5	E	SANDALWOOD
8	F	DARK BROWN
9	G	DARK GREEN

00A-13

00-7 VEHICLE AND MAJOR COMPONENT

IDENTIFICATION NUMBERS

a. Vehicle Identification Numbers

1971 Buick models have a serial number identification plate attached to the top of the instrument panel on the drivers side to be viewed through the windshield from outside the car. An example of this plate is shown in Figure 00-11.

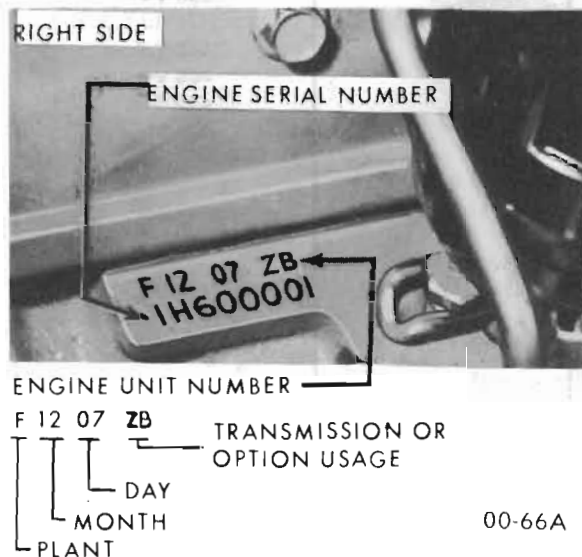

Figure 00-10 - Engine Serial Number and Production Code Location (L-6)

b. Fisher Body Number Plate

Body identification is provided by the Fisher Body Number Plate.

Information such as style and body numbers, trim numbers, and paint color code is contained on this plate. Refer to the 1971 Fisher Body Service Manual for detailed information about this plate.

c. Engine Numbers

1971 Buick engines are stamped with two different identification codes. *One is an engine production code number.* This identifies the engine and its approximate production date. Refer to Group 60 for Engine Usage.

The other code is the *engine serial number* and is the same number found on the vehicle identification plate mentioned previously in Paragraph a. This is the legal engine number and is used on registrations, titles, and other legal documents, while the production code number is used to identify the engine on product reports and other factory correspondence.

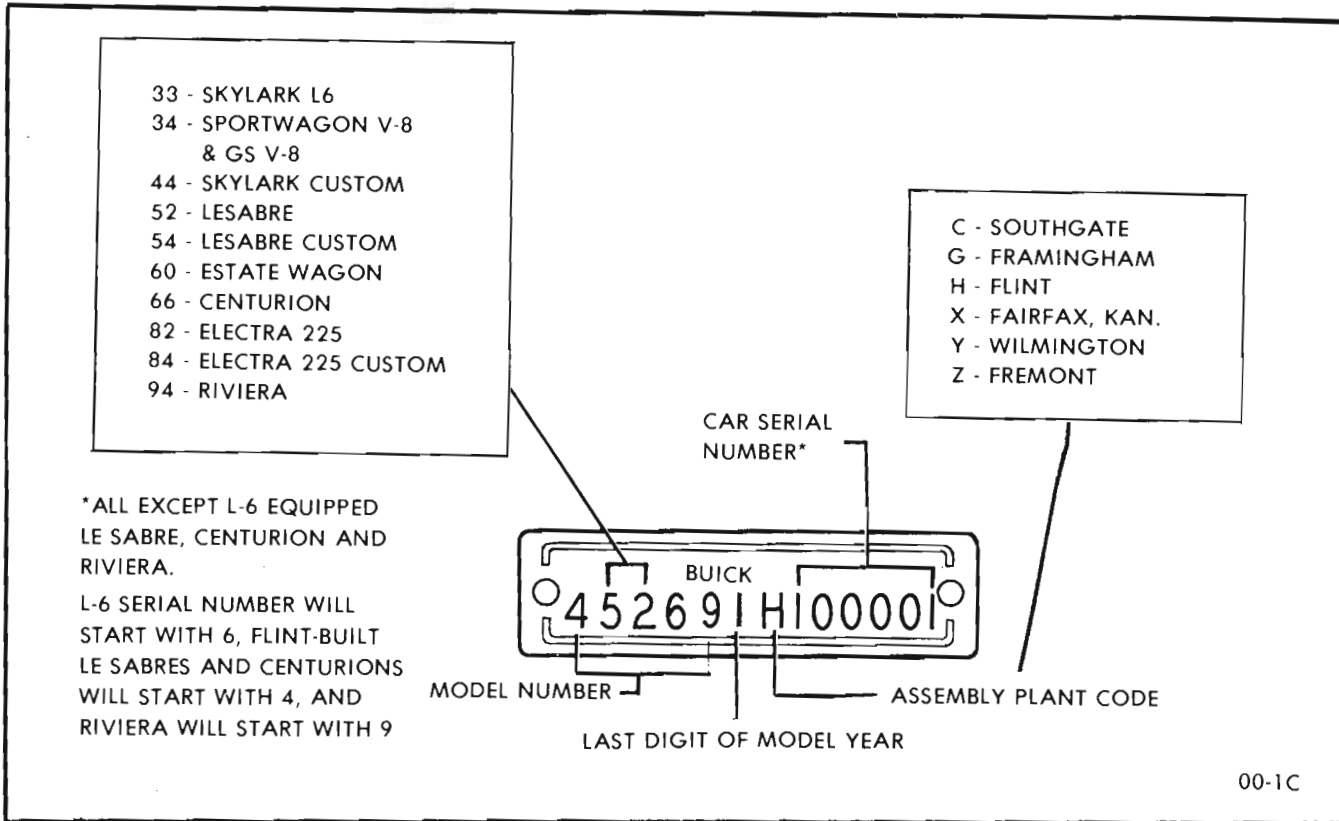

00-1C

Figure 00-11 - Vehicle Identification Plate

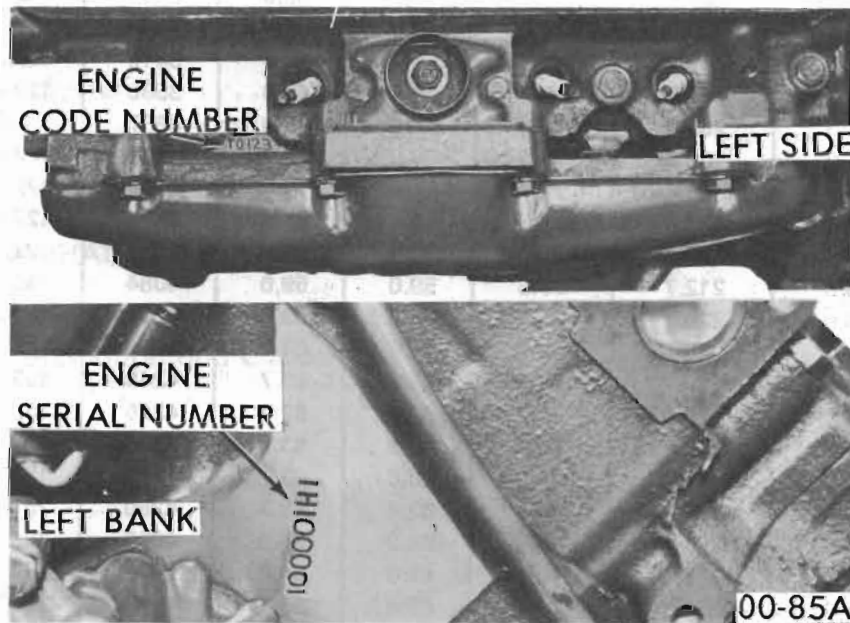

Figure 00-12 -Engine Serial Number and Production Code Location (350 Cu.In.)

d. Automatic Transmission Identification Numbers

Refer to Groups 75 and 76.

e. Manual Transmission Identification Numbers

Refer to Group 72.

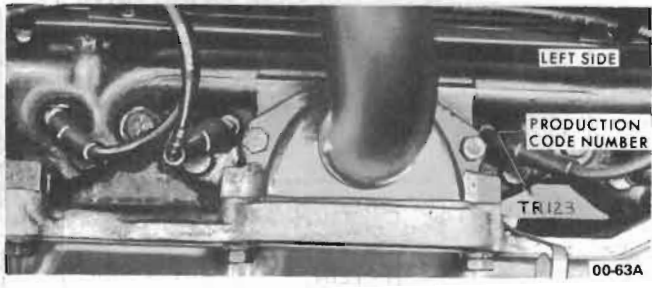
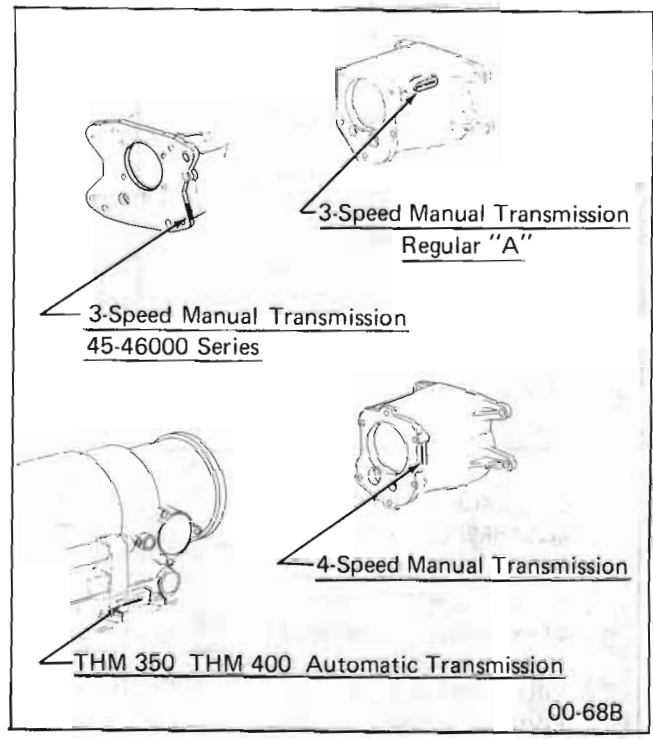

Figure 00-13 - Engine Serial Number and Production Code Location (455 Cu.In.)

Figure 00-14 - Transmission Identification Number Location



00-8 GENERAL SPECIFICATIONS

1971 Models	Wheel Base	Overall Length	Overall Width	Front Tread	Rear Tread	Curb* Weight Pounds	Liquid Weight	
							Fuel	Coolant
43327	112.0	202.8	77.3	59.0	59.0	3363	122.0	35.0
43337	112.0	202.8	77.3	59.0	59.0	3369	122.0	35.0
43369	116.0	206.8	77.3	59.0	59.0	3415	122.0	35.0
44437	112.0	202.8	77.3	59.0	59.0	3580	122.0	36.0
44467	112.0	202.8	77.3	59.0	59.0	3637	122.0	36.0
44439	116.0	206.8	77.3	59.0	59.0	3712	122.0	36.0
44469	116.0	206.8	77.3	59.0	59.0	3619	122.0	36.0
43437	112.0	202.8	77.3	59.0	59.0	3580	122.0	36.0
43467	112.0	202.8	77.3	59.0	59.0	3634	122.0	36.0
43436	116.0	212.7	77.3	59.0	59.0	4084	140	36.0
45257	124.0	220.1	79.7	63.8	63.7	4211	153	36.0
45239	124.0	220.1	79.7	63.8	63.7	4254	153	36.0
45269	124.0	220.1	79.7	63.8	63.7	4248	153	36.0
45457	124.0	220.1	79.7	63.8	63.7	4225	153	36.0
45467	124.0	220.1	79.7	63.8	63.7	4289	153	36.0
45439	124.0	220.1	79.7	63.8	63.7	4266	153	36.0
45469	124.0	220.1	79.7	63.8	63.7	4260	153	36.0
46035	127.0	227.1	79.7	64.0	64.0	4995	153	41.0
46045	127.0	227.1	79.7	64.0	64.0	5079	153	41.0
46647	124.0	220.1	79.7	63.8	63.7	4390	153	41.0
46667	124.0	220.1	79.7	63.8	63.7	4445	153	41.0
46639	124.0	220.1	79.7	63.8	63.7	4472	153	41.0
48237	127.0	226.4	79.7	63.8	63.7	4490	153	41.0
48239	127.0	226.4	79.7	63.8	63.7	4543	153	41.0
48437	127.0	226.4	79.7	63.8	63.7	4570	153	41.0
48439	127.0	226.4	79.7	63.8	63.7	4570	153	41.0
49487	122.0	217.4	79.9	63.8	63.7	4435	128	41.0

*Estimated Curb Weights Only