

# SECTION F

## INSTRUMENT PANEL MISCELLANEOUS ITEMS

### CONTENTS

Division	Subject	Paragraph
I	TROUBLE DIAGNOSIS:	
	Fuel Gauge . . . . .	120-28
	Fuel Gauge Trouble Chart . . . . .	120-29
	Speedometer and Ignition Key Warning Buzzer Diagnosis . . . . .	120-30
II	DESCRIPTION AND OPERATION:	
	Electric Clock . . . . .	120-31
	Fuel Gauge System . . . . .	120-32
	Speedometer . . . . .	120-33
III	ADJUSTMENTS AND MINOR SERVICE: (Not Applicable)	-
IV	REMOVAL AND INSTALLATION: (Not Applicable)	-
V	OVERHAUL AND MAJOR SERVICE: (Not Applicable)	-
VI	SPECIFICATIONS: (Not Applicable)	-

## DIVISION I

### TROUBLE DIAGNOSIS

#### 120-28 FUEL GAUGE - TROUBLE DIAGNOSIS

If the gasoline gage does not operate properly, the dash unit, tank unit wiring and the tank unit should be separately tested to determine which is at fault. The units and wiring may be tested by using Gas Gage Tester J-22344. To use the tester, disconnect the tan wire from the gas gauge tank unit terminal and plug the tester into the end of the tan wire. Connect the other tester lead to a good ground. With the tester switched into the empty position, the gas gauge dash unit pointer should touch the empty line or rest slightly below; with the tester switched to the full position, the gas gauge dash unit pointer should touch the full line or rest slightly above it.

If the gas gauge system fails to pass these two tests, refer to the following chart to diagnose the trouble.

#### 120-30 SPEEDOMETER - TROUBLE DIAGNOSIS

##### a. Checking Noisy Speedometer

1. Jack up rear wheels in a safe manner and close car windows to exclude outside noises.
2. With transmission in direct drive, run slowly from 0 to 50 MPH and back to 0, noting speed range where noise appears.
3. Apply brakes and shift transmission to park position, then run engine through same speed range as before.
4. If the noise continues even with the transmission output shaft stationary, something other than the speedometer installation is at fault.
5. If noise disappears with transmission stationary, check further for cause of noise by checking for proper installation of speedometer cable as shown in Figures 120-45 through 50.
6. If cable installation is okay, next remove inner cable from casing. 7. If noise stops with inner cable removed, speedometer or cable is at fault. Inspect cable as described in subparagraph c.

##### b. Inspection of Speedometer Cable and Casing

If the speedometer installation appears to be noisy or the speed indicator wavers, inspect the cable casing for damage, sharp bends, for being out-of position in the supporting clips. See Figures 120-70 through 73. If casing is in good condition and properly installed, remove inner cable for inspection. If casing is kinked, replace it.

1. Disconnect cable casing at speedometer head, then pull

inner cable out of upper end of casing.

2. Inspect cable for worn spots or breaks. Check cable for kinks by holding one end vertically in each hand and turning cable slowly; if cable is kinked, the loop will "flop". Replace a cable which has kinks or bent tips.
3. Before installing a new inner cable, work AC spec. 640 speedometer cable lubricant into the cable thoroughly, then wipe off all excess lubricant. Since the speedometer casing has a Delrin (plastic) liner, this lubricant is used as a rust preventive only.
4. If noise is still present, install a new speedometer cable assembly.
5. If this does not correct noise, have speedometer head checked by a UMS Service Station.

##### c. Trouble-Shooting Speedometer and Ignition Key Buzzer

Since both circuits simply provide a separate ground for the same buzzer, trouble-shooting will involve both circuits. See Figure 120-76. Check ignition key buzzer circuit by turning the ignition key to the accessory position and opening the driver's door. Check speedometer buzzer by setting speedometer pointer to a low speed, raising rear wheels of car, and running car in drive until the speedometer speed comes up to the set buzzer speed.

##### 1. Buzzer Will Not Operate On Either Circuit.

(a) Check buzzer operation by sticking a prod in pink wire terminal at buzzer and running a jumper to ground. If buzzer now operates, circuit is okay through buzzer and trouble must be in wire to speedometer and door jamb switch. If buzzer still does not operate, replace buzzer.

##### 2. Speedometer Buzzer Operates - Ignition Key Buzzer Does Not Operate.

(a) Remove driver's door jamb switch. Ground black wire with ignition key in accessory position. If buzzer now operates, replace door jamb switch.

(b) If buzzer still does not operate, remove column lock cylinder buzzer switch and place a jumper between the buzzer terminals. If buzzer now operates, replace column lock cylinder buzzer switch.

##### 3. Ignition Key Buzzer Operates - Speedometer Buzzer Does Not Operate.

(a) Disconnect pink wire from speedometer and run jumper to ground. If buzzer now operates, circuit is okay as far as speedometer and trouble is in speedometer or in cluster ground circuit.

(b) If cluster ground wire is disconnected, there will be a poor ground for the speedometer buzzer, panel illumination lamps and wiper motor. To check for adequate cluster ground, turn on panel lights full bright, then turn on wiper

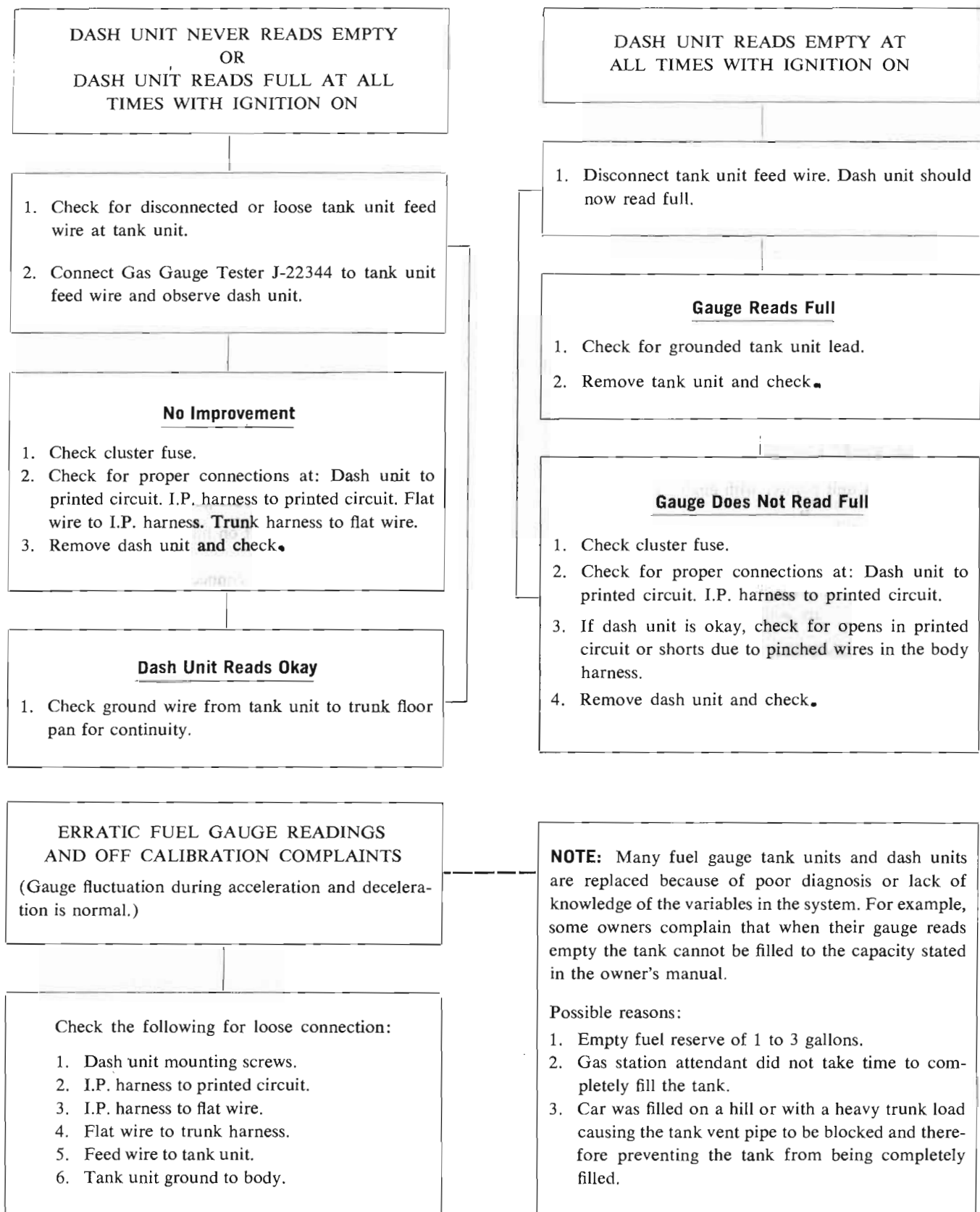

Figure 120-67 Fuel Gauge Trouble Diagnosis

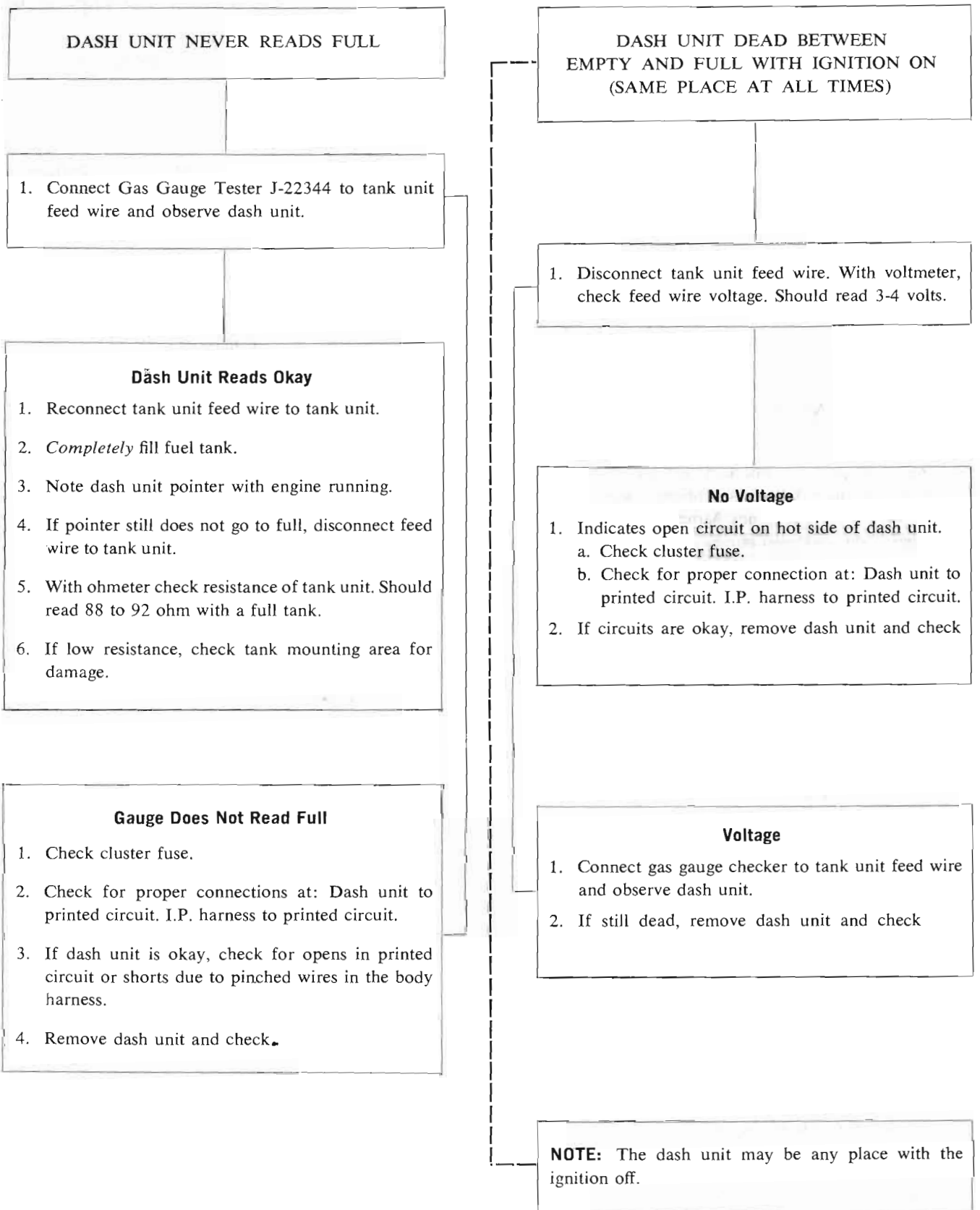

Figure 120-68 Fuel Gauge Trouble Diagnosis

motor and note panel light brightness. If panel lights do not dim, cluster has an adequate ground and trouble in (a) above must be due to a defect in speedometer. *A defective speedometer assembly must be sent to the nearest UMS Service Station for repairs.*

#### 4. Buzzer Operates Continuously.

(a) Eliminate possibility of a continuous ground at door jamb switch by removing switch from door jamb. (b) Eliminate possibility of a continuous ground in speedometer by disconnecting pink wire from speedometer.

(c) If neither (a) or (b) stops buzzer, pink wire must be pinched or accidentally grounded between buzzer and one of these units.

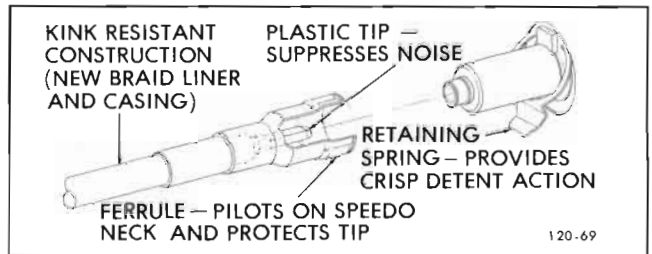

Figure 120-69 Quick Connect Speedo Cable

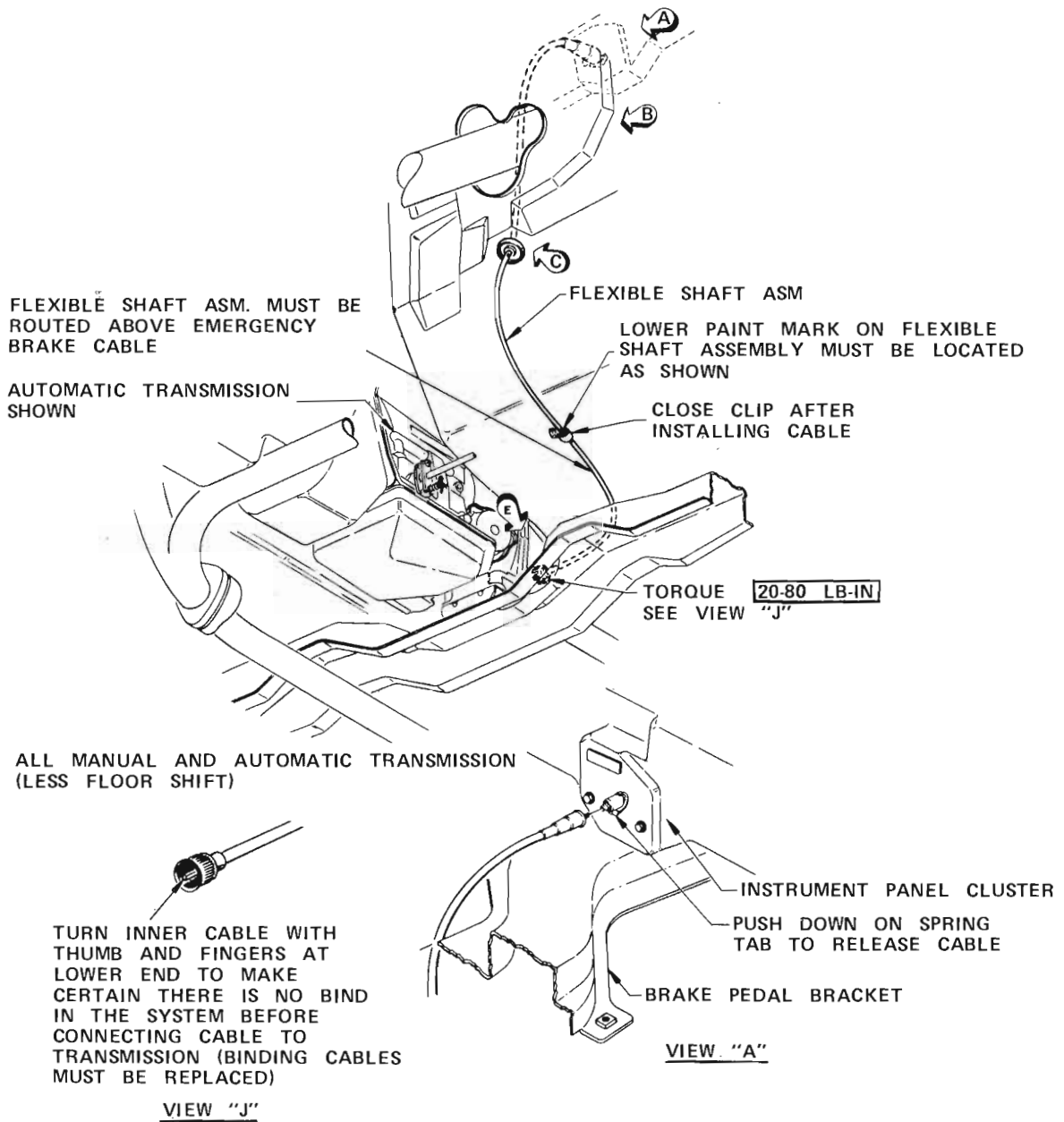
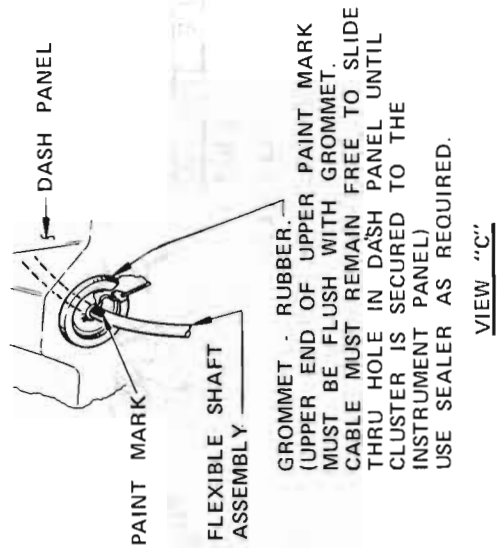
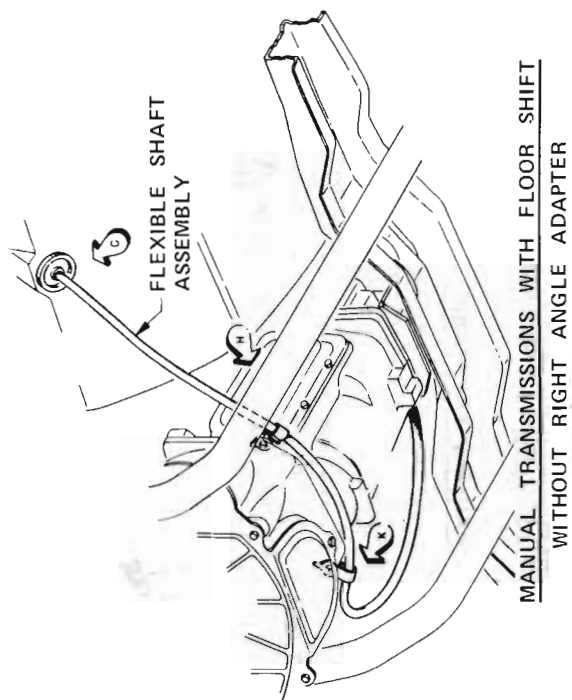
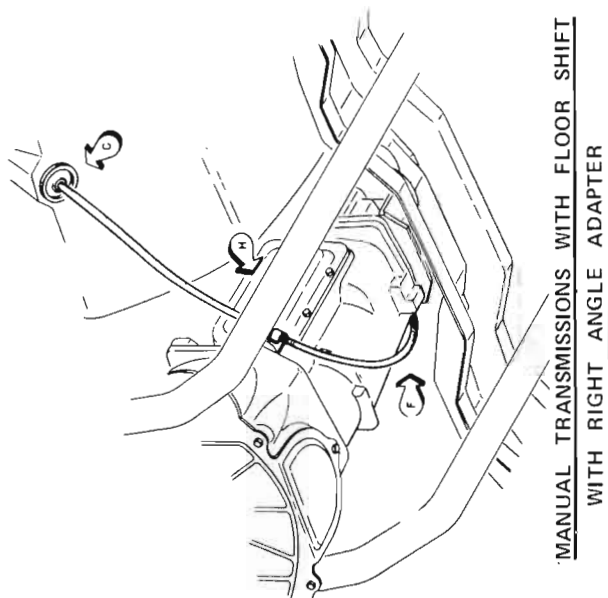
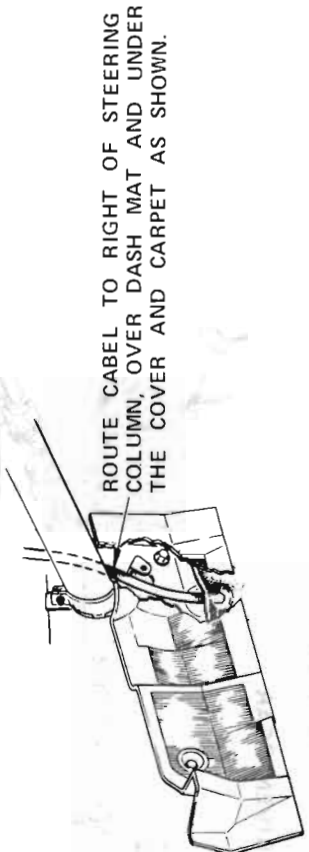

Figure 120-70 Speedo Cable Installation - 43-44000 Series



GROMMET - RUBBER. UPPER END OF UPPER PAINT MARK MUST BE FLUSH WITH GROMMET. CABLE MUST REMAIN FREE TO SLIDE THRU HOLE IN DASH PANEL UNTIL CLUSTER IS SECURED TO THE INSTRUMENT PANEL) USE SEALER AS REQUIRED.



120-71

Figure 120-71 Speedo Cable Installation - 43-44000 Series

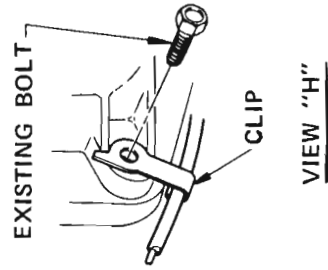
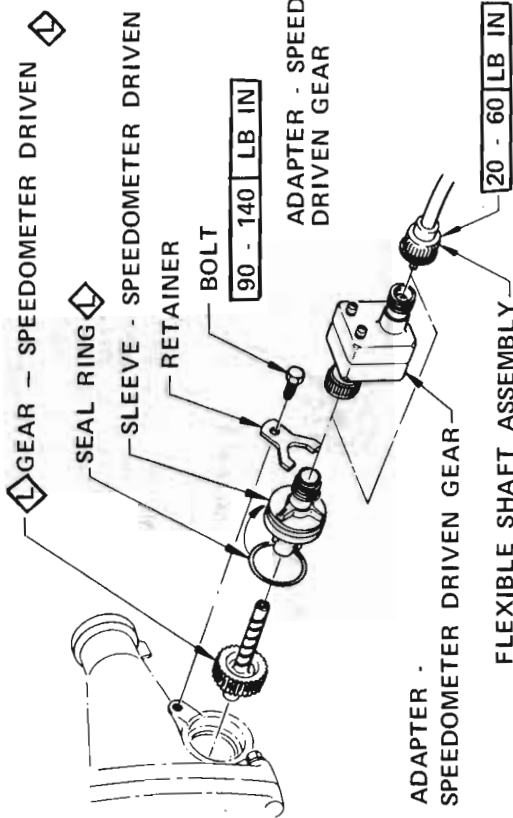
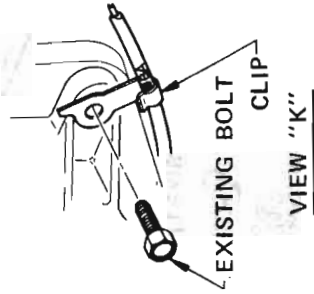
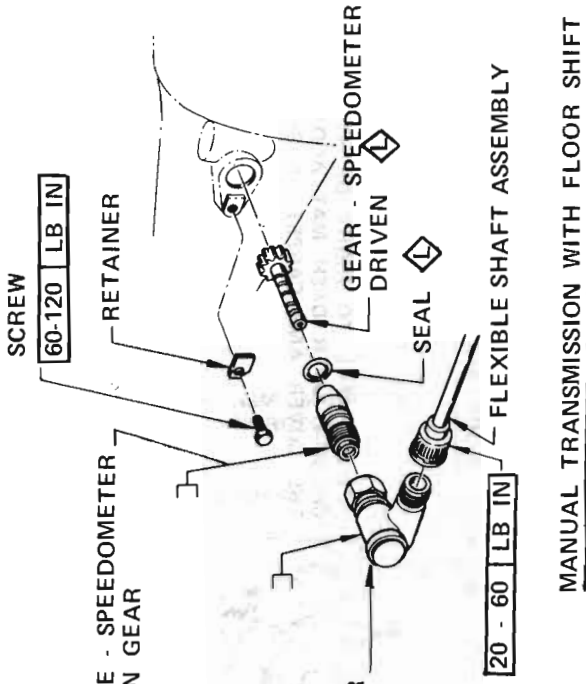

MANUAL TRANSMISSION WITH FLOOR SHIFT

Figure 120-72 Speedo Cable Installation - 43-44000 Series



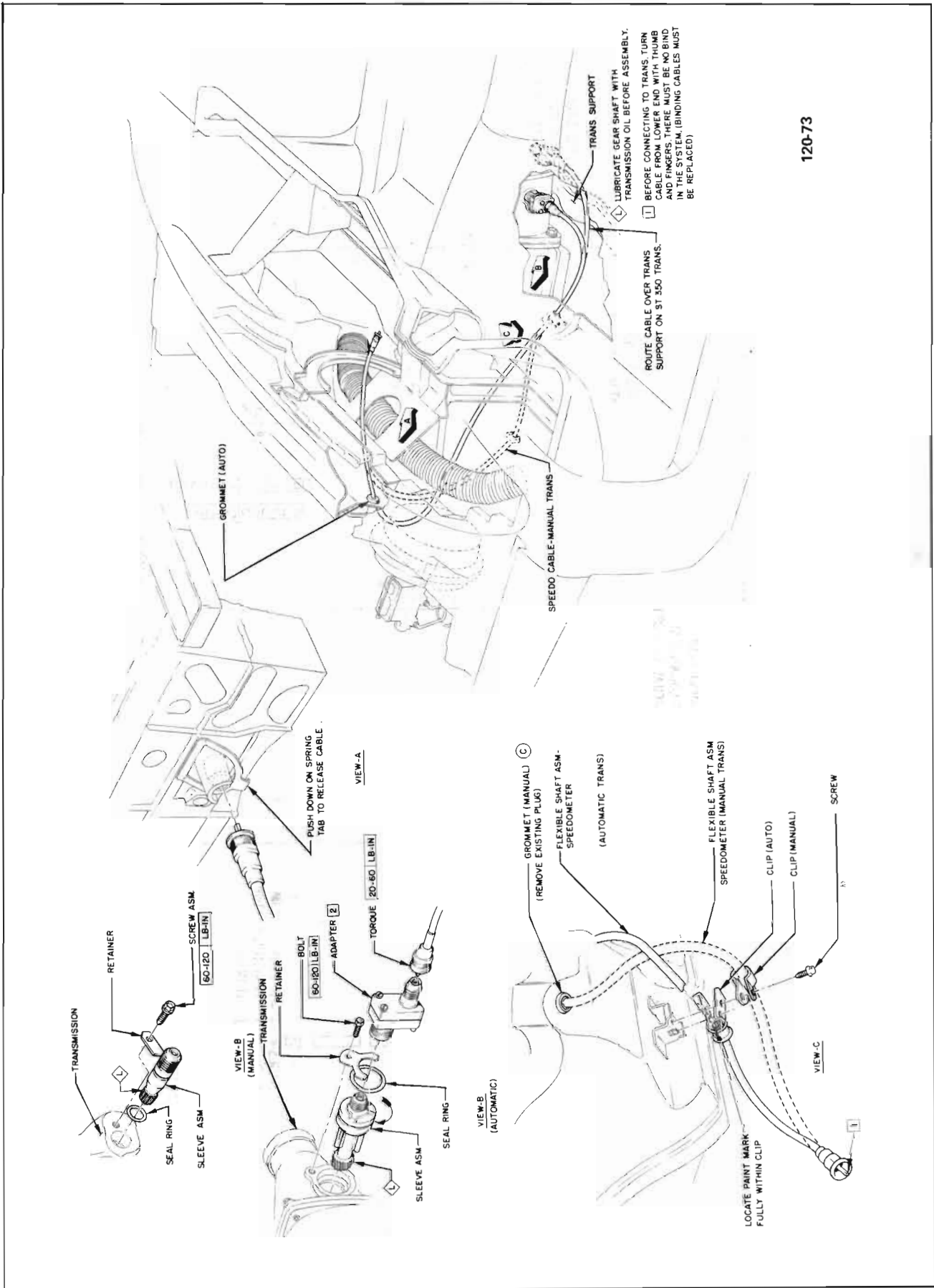
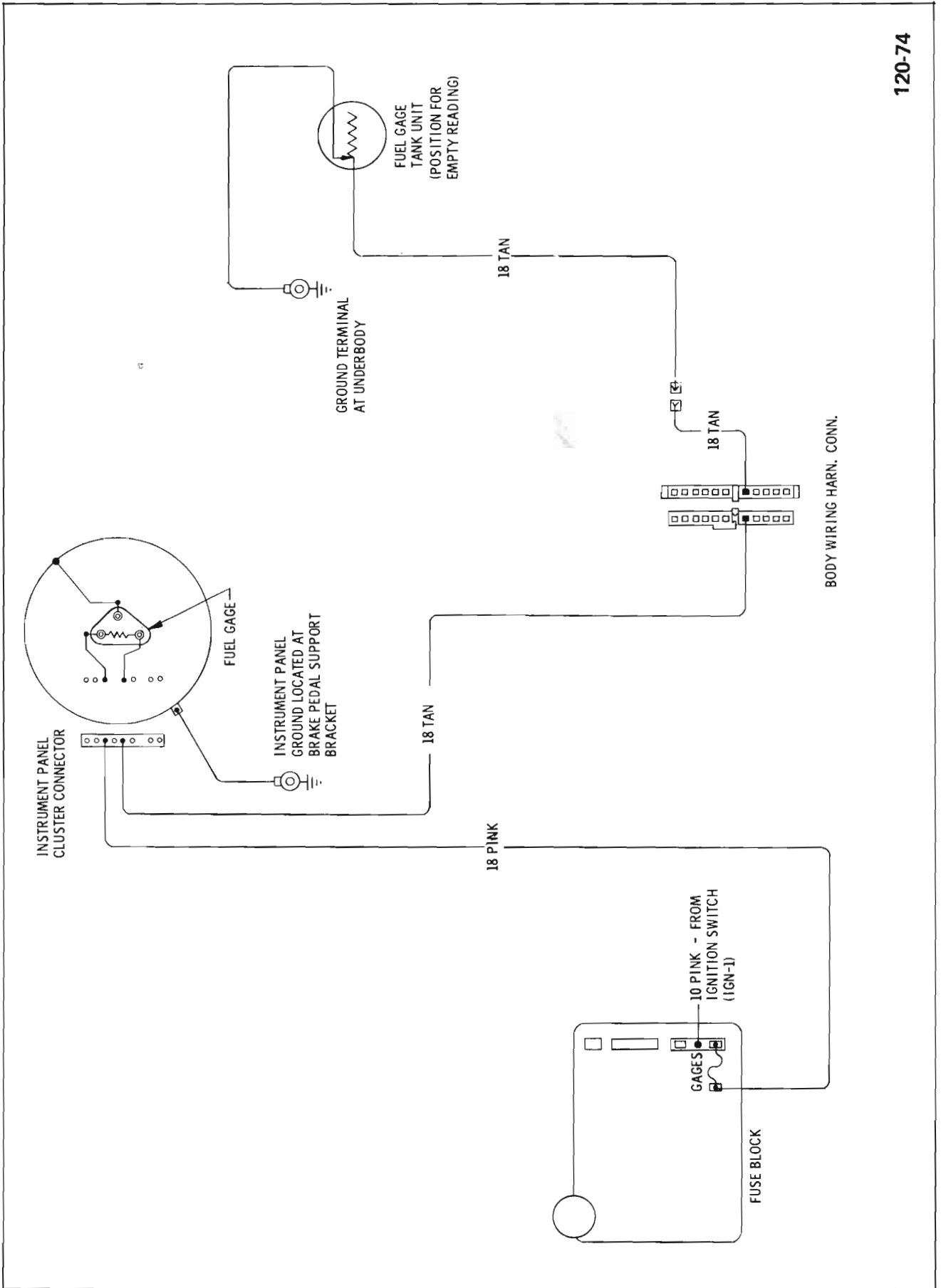

Figure 120-73 Speedo Cable Installation - 45-46-48-49000 Series



120-74

Figure 120-74 Fuel Gauge Wiring Diagram - 43-44000 Series



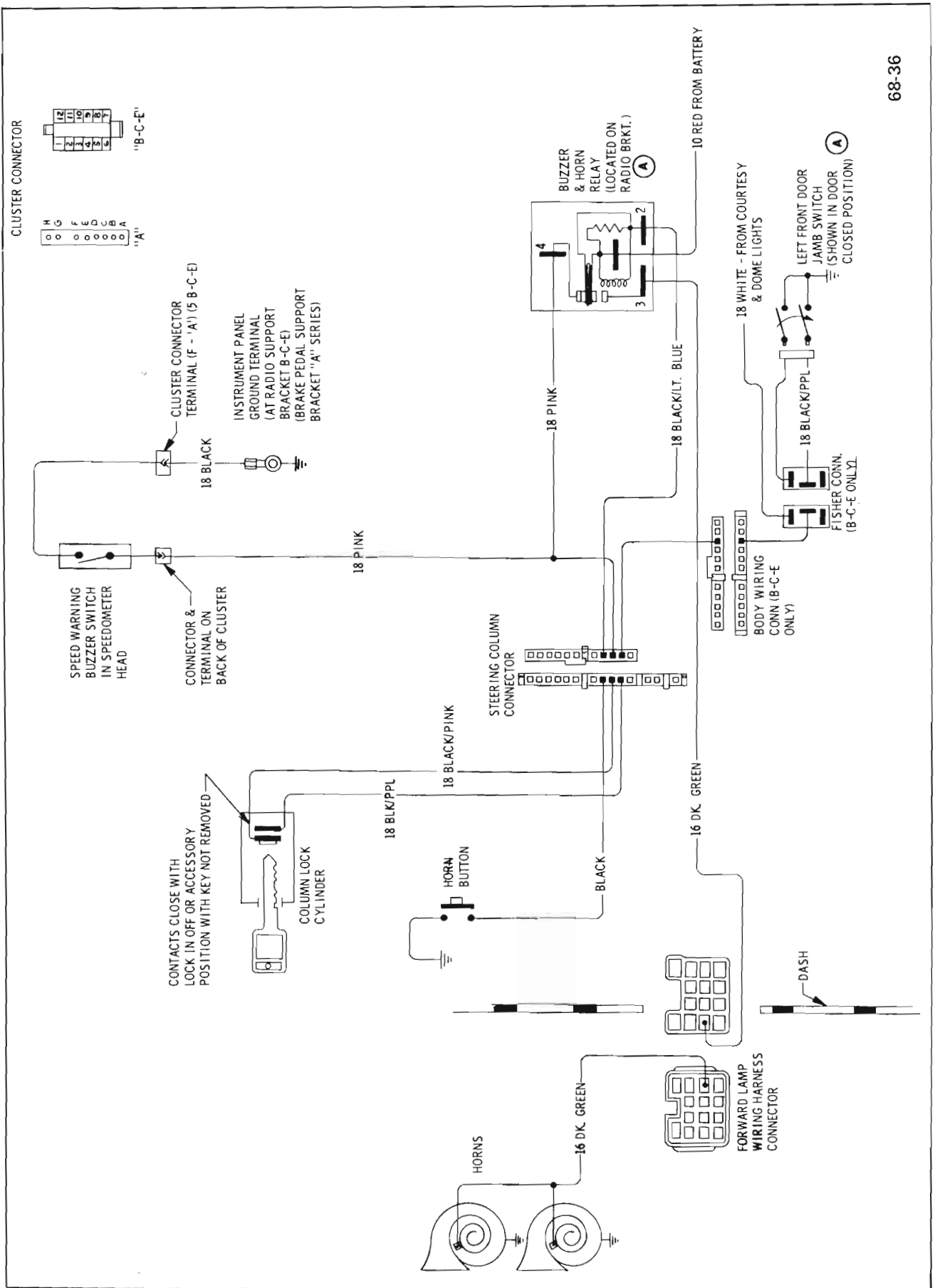

Figure 120-76 Buzzer and Horn Relay Wiring Diagram

## DIVISION II

### DESCRIPTION AND OPERATION

#### 120-30 ELECTRIC CLOCK

The electric clock is mounted in the right of the instrument cluster housing. The clock wiring circuit is protected by a fuse on the fuse block. Clock lighting is controlled by the rheostat in the lighting switch and is protected by the instrument lamps fuse on the fuse block.

##### a. Clock Time Reset and Automatic Regulation

The electric clock has a sweep-second hand and an automatic regulator. A reset knob extends through the glass of the clock dial. To reset the time, pull the knob out and turn in either direction as required.

There is no regulator because regulation is accomplished automatically by the action of resetting the time. If a clock is running fast, the action of turning the hands back to correct the time will automatically cause the clock to run slightly slower; if a clock is running slow, the action of turning the hands forward to correct the time will automatically cause the clock to run slightly faster (10 to 45 seconds per day). If clock varies over 10 minutes a day, the clock will never adjust sufficiently and must be disassembled for repair.

A lock-out feature prevents the regulator mechanism from being moved more than once during a rewind period (approximately 2 minutes), regardless of the number of times the clock reset is operated. After clock rewinds, if it is again reset, automatic regulation will take place.

##### b. Clock Service

The clock manufacturers have established Authorized Service Stations in many cities throughout the United States and Canada. These service stations are prepared to carry out terms of the manufacturer's warranty and also to perform any repairs made necessary through use of clock.

When a clock requires warranty service or repairs other than regulation, it should be removed by the Buick dealer and sent to the nearest authorized service station. *The manufacturer's warranty is void if repairs have been attempted outside of an authorized service station.*

#### 120-31 FUEL GAUGE SYSTEM - DESCRIPTION AND OPERATION

The gasoline gauge system consists of a dash unit (located in the instrument cluster), a tank unit (located in the gasoline tank), a wire between these two units, and a wire to supply battery voltage to the dash unit. See Figure 120-74 or 75. The single tank unit terminal is connected to one dash unit terminal with a tan wire. The other dash

unit terminal is connected to the ignition switch, through the "GAGES" fuse, with a pink wire, so that voltage to energize the system is supplied only when the ignition switch is turned on. The dash unit has a balanced-type pointer; when the ignition is turned off, the pointer may come to rest any place on the dial.

The dash unit pointer is moved by changing the balance between the magnetic pull of three coils in the unit. This balance is controlled by action of the tank unit which contains a variable rheostat, the value of which varies with movement of a float. The tank unit is mounted in the tank so that the float rises and falls on the surface of the gasoline. The float is adjusted to provide approximately 1 to 3 gallons reserve when the dash unit pointer is at the "E" position.

When the ignition switch is "On" and the float is in the full position (maximum resistance for the tan wire to ground), the current flow to ground is through the resistor, empty coil, the full coil and the bucking coil. Due to the fact that the bucking coil opposes the empty coil, the full coil has the stronger magnetic pull, and the dash unit pointer is pulled to the "F" position. When the float is in the empty position (practically no resistance for tan wire to ground), the current flow is through the resistor, the empty coil and the tan wire to ground at the tank unit. The dash unit pointer is thus pulled to the "E" position.

#### 120-32 SPEEDOMETER

##### a. Speedometer Heads

The speedometer head has a magnetic speed indicator and a gear driven odometer. It is driven by a flexible cable connected to a worm gear in the transmission rear bearing retainer.

The speed indicating portion of the speedometer operates on the magnetic principle. There is a permanent magnet in the speedometer head which rotates at the same speed as the cable. This magnet exerts a pull on a speed cup causing it to move through an arc in direct ratio to the revolving magnet speed. A pointer is attached to the speed cup spindle to indicate speed on the speedometer dial. A calibrated hair spring (part of speed cup) opposes the magnetic pull on the speed cup so the pointer indicates speed accurately; this spring also rotates the cup and pointer to zero when the car stops.

##### b. Speedometer Buzzer

The speedometer buzzer consists of a buzzer which may be adjusted by the driver to sound at any speed between 30 and 120 MPH by turning a knob at the left of the speedometer face. The speed at which the buzzer is set is indicated by a special pointer in the speedometer face.

The speed alert electrical circuit starts at the battery. It feeds through the fusible links to the starter solenoid, to the buzzer contacts. After passing through the buzzer contacts, a very small amount of current goes through a

resistor to ground and the rest of the current passes through a pink wire to the connector located on the speedometer case.

In the speedometer, current is conducted from the separate buzzer connector through a wire to an insulated pin in the lower end of the buzzer pointer. As the speedometer pointer moves up to coincide with the buzzer pointer, a light grounding hair spring on the lower end of the speed-

ometer pointer makes contact with the "hot" insulated pin on the speed alert pointer.

This grounds the circuit, causing the buzzer to buzz. If the car speed is increased beyond the buzzer setting, the insulated pin on the safety-buzzer pointer "picks-up" the hair spring as the speedometer pointer passes under the buzzer pointer and the light grounding hair spring winds-up slightly.